

# Quick Start Guide

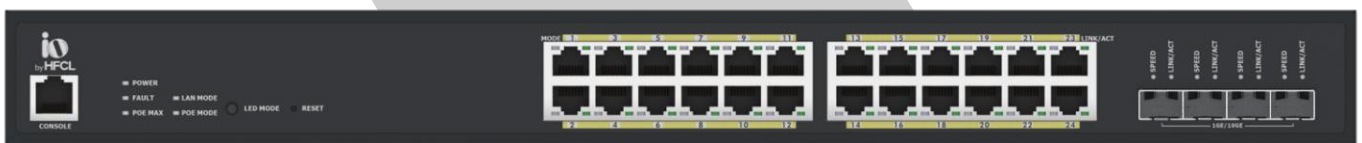

**HSP-IO-24GE4XS-C1PA**  
**24Port PoE+ L2**  
**Managed Switch**

## Also Applicable on:

- **HSP-IO-24GE4XS-C1A**  
24-Port, Non PoE, L2 Managed Switch,  
4x1/10G SFP+ Uplinks, Single AC Power Supply

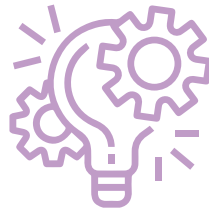

## Advanced GUI

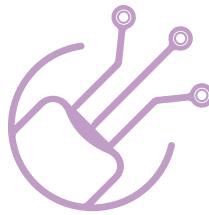

## High Speed Fiber & Copper Based Backhaul



## Rich Layer-2 Features

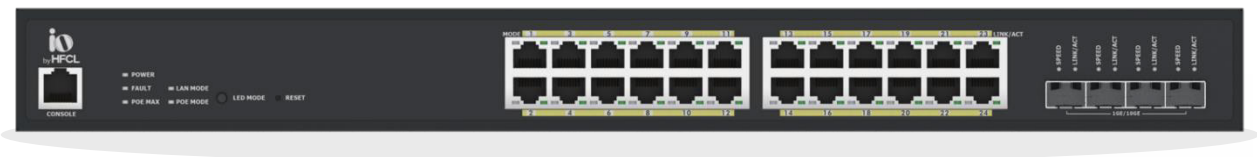

## Introduction

Thank you for choosing 24-port managed Switch from HFCL Switching Platform (C1 Series). PoE Variants Suitable in an enterprise/telco/campus environment to connect end PoE clients like Wi-Fi AP, CCTV, P2P, P2MP, IoT etc. Non-PoE Variants Suitable to connect Small Cells/BTS, P2P/P2MP etc. in telco environment and Desktops/Servers, IP-Phone etc. in an Enterprise/Campus environment.

### Front View:

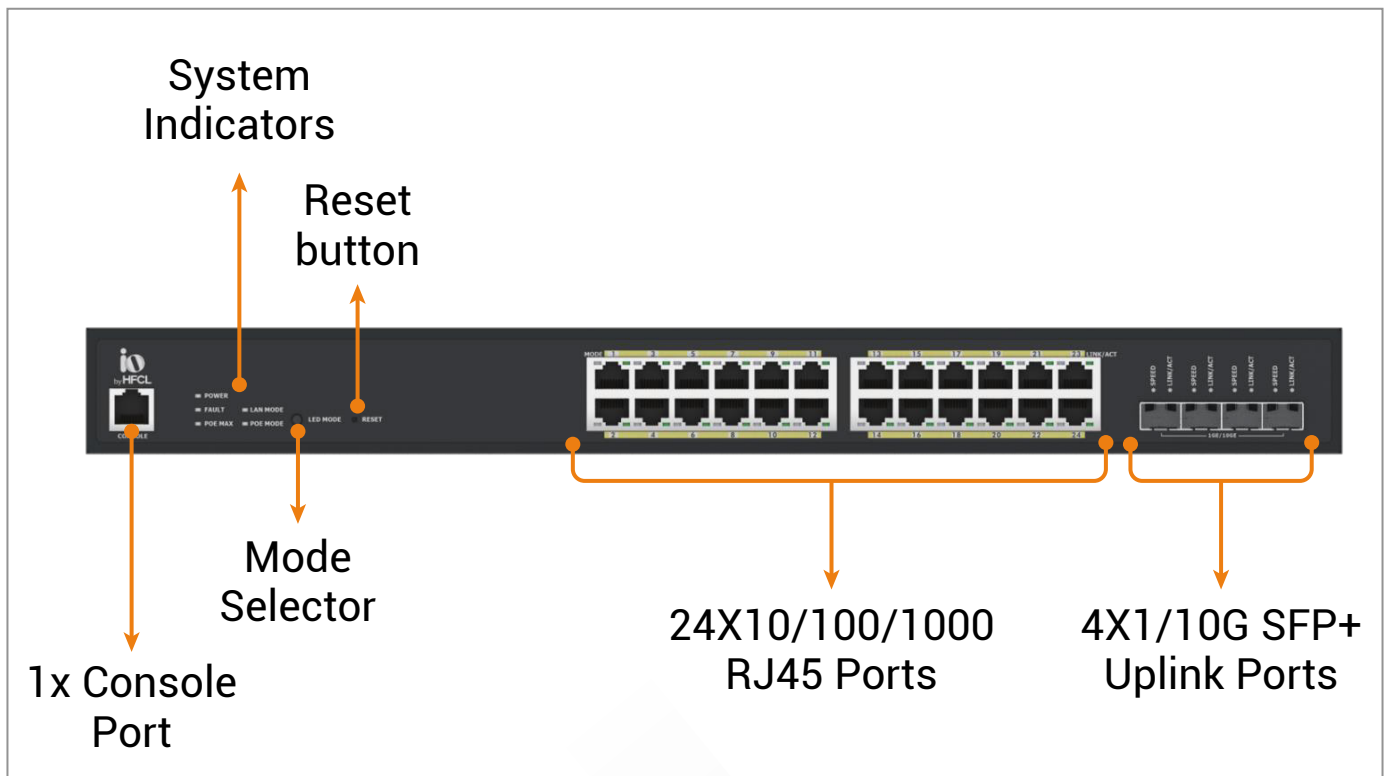

## :::: Packaging Content: ::::

- :::: 1. 24 Port Switch Qty: 1 number
- :::: 2. Mounting clamps with screws
- :::: 3. Power Supply cable: 1 Pc



## Installation:

Assembly of brackets for Rack mounting described in below diagram for 24 Port L2 managed Switch Model.

**Step 1.** Attach the mounting brackets to both sides of the chassis. Insert screws and tighten them with a screwdriver to secure the brackets.

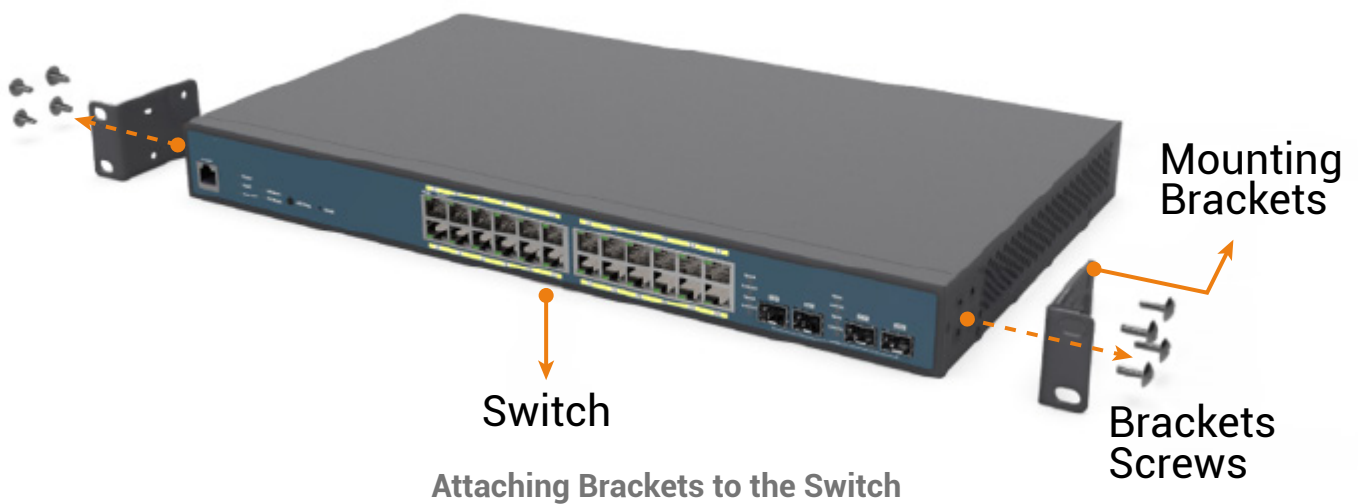

**Step 2.** Place the switch on a rack shelf in the rack. Push it in until the oval holes in the brackets align with the mounting holes in the rack posts.

**Step 3.** Attach the brackets to the posts. Insert screws and tighten them.



## :::: Login Access ::::

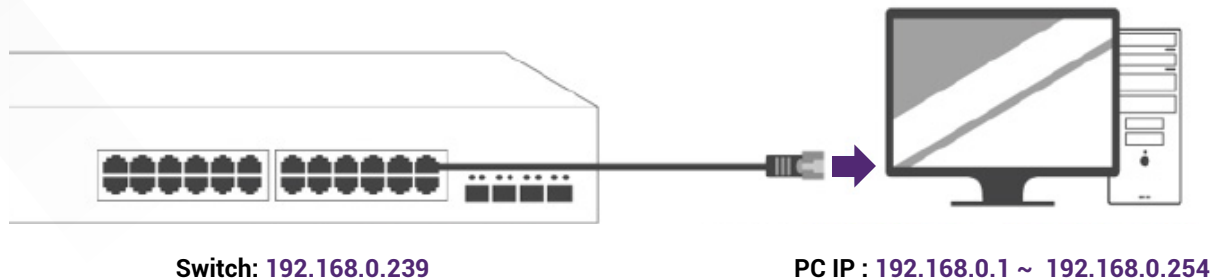

### Access Via Web-GUI:

#### Steps:

- :::: 1. Connect your PC to the Switch and ensure its IP address is in the same subnet, default IP of Switch is 192.168.0.239/24
- :::: 2. Open the web browser and enter the URL:  
http://192.168.0.239 to access the Switch's local web GUI.
- :::: 3. Use the default login credentials (Username is "admin" and Password is "password") to log in to the Switch's local web page.

If your PC is configured correctly, you should see the login page of the Switch as shown by Image:

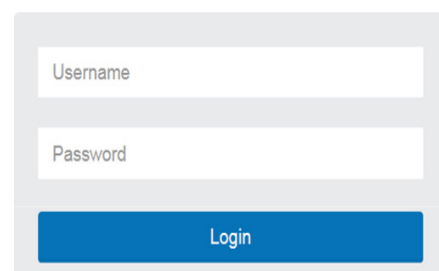

### Access Via Console:

The console access to the Switch can be obtained via the RJ45 console port. An administrator can access device using command line interface (CLI) with following console port setting as part of factory default configuration.

**Speed:** 115200 bps | **Data bits:** 8 | **Stop bit:** 1  
**Parity:** None | **Flow control:** Hardware

## Product Specification

### 24 Port L3 Managed Switch Specifications

Capacity	Switching: 128 Gbps, Forwarding: 95.232 MPPS
Port Configuration	24x10/100/1000M RJ45 ports
PoE Feature	PoE Budget - 410W, PoE Configuration
Uplink Ports	4x1/10G SFP+ Uplink Ports
L2 Features	Support 4094 VLAN IDs, 16K MAC Table
Security	L2, L3, L4 ACLs, 802.1X Port Authentication with RADIUS, Port Security
Storm Control	Broadcast, Multicast and Unknown Unicast
Management	CLI, Telnet, SSH, SNMP v1/v2c/v3, Web GUI.
Temperature	Operating: 0°C to 40°C
Power Input	100V to 240V for AC

## LED Description

LED	LED indicator	Color	Status	Description
System	Power	Green	Flashing	Before system boot
			Solid On	Power On
			Light Off	Power Off
	Fault	Amber	Solid On	Any fault
			Light Off	Normal
	PoE Max	Amber	Solid On	When the total PoE output power achieve max power budget
			Light Off	System still have spare power for new PD
	LAN Mode	Green	Solid On	Select LED Mode to Ethernet Mode
PoE Mode	Green	Solid On	Select LED Mode to PoE Mode	
Ethernet Port	LAN Mode	Green	Solid On	Speed 1000 Mbps
		Amber	Solid On	Speed 100 Mbps
		Off	Light Off	Speed 10 Mbps
	PoE Mode	Green	Solid On	Power feeding
		Amber	Solid On	Error Condition
		Off	Light Off	No Power feeding
	Link/Act	Green	Solid On	Link
		Amber	Flashing	Transmit or receive on this port
		Off	Light Off	No Link

LED	LED indicator	Color	Status	Description
SFP Slot	Link/Act	Green	Solid On	Link
			Flashing	Transmit or receive on this port
			Light Off	No Link

**Reset to default:** Press and hold for over 10 seconds, and all ports LED will go off and on. Then the device will be reset to factory default settings.

**Change LED display mode:** Press the button to change the LED mode to display the PoE status of PoE-enabled ports.

## Safety Precautions



Observe the following safety precautions to avoid damage to the Switch:

-  Do not power the device during installation.

---

-  Keep away from high voltage cables.

---

-  Do not power off the unit in the middle of an upgrade process.

---

-  Do not open the enclosure.



Contact Us:

- ✉ [iosupport@hfcl.com](mailto:iosupport@hfcl.com)
- 🌐 [hfcl.com](http://hfcl.com) | [io.hfcl.com](http://io.hfcl.com)
- 📍 8, Commercial Complex,  
Masjid Moth, Greater Kailash-II,  
New Delhi- 110048